

Elementi speciali mod. Noblesse Oblige

Special furnishing units, mod. Noblesse Oblige
 Eléments spéciaux, mod. Noblesse Oblige

LARGHEZZA WIDTH LARGEUR	IMBALLO PACKAGE PAQUET	CODICE CODE CODE	CODICE CODE CODE	1	2	3	4	5	6	7	8	9	10	11	12	13
cm	m ³	DX RIGHT DROIT	SX LEFT GAUCHE													

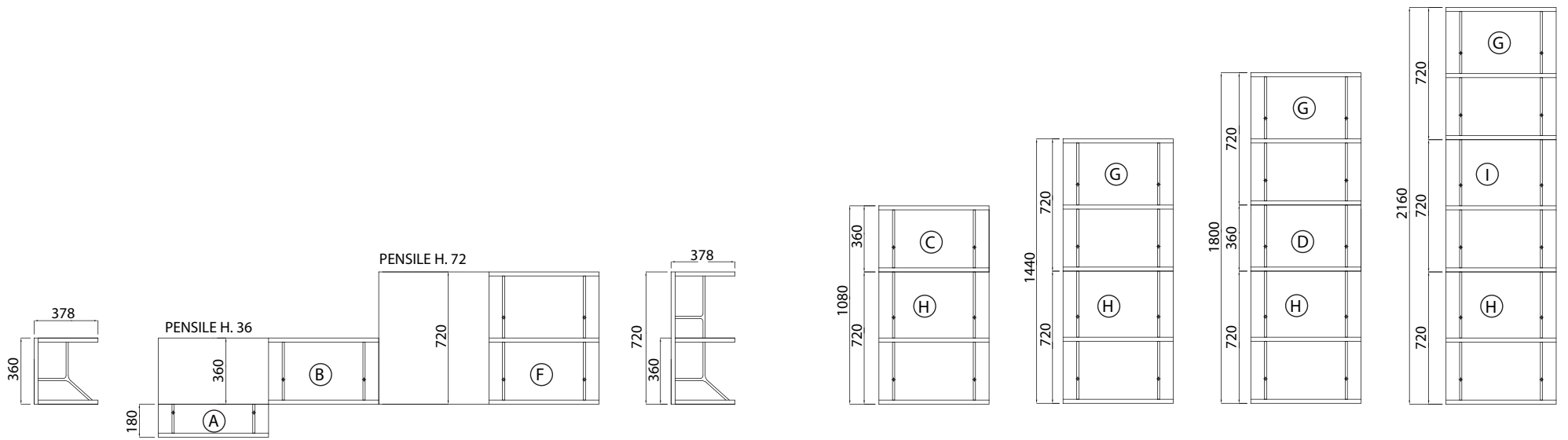

N.B.: non disponibili in finitura cemento
 N.B.: not available on cement finish
 N.B.: nes pas disponible en finition ciment

A 	Sottopensile h. 18 prof. 20 giorno sp. 1,8 Noblesse Oblige	60	0,028	0075960				355	385		392	423	444	485	494		
	Open front midway unit h. 18 depth 20 th. 1,8 Noblesse Oblige	90	0,041	0075961				360	393		398	433	454	498	507		
	Sous-haut à jour h. 18 pr. 20 ép. 1,8 Noblesse Oblige	120	0,054	0075962				375	418		427	472	502	560	573		
B 	Pensile h. 36 prof. 37,8 giorno sp. 2,2 Noblesse Oblige	60	0,103	0075963				589	630		703	734	749	832	848		
	Open front wall cabinet h. 36 depth 37,8 th. 2,2 Noblesse Oblige	90	0,139	0075964				633	707		785	827	883	1.007	1.033		
	Haut à jour h. 36 prof. 37,8 ép. 2,2 Noblesse Oblige	120	0,184	0075965				677	782		888	939	1.015	1.182	1.217		
C 	Pensile h. 36 prof. 37,8 giorno sp. 2,2 Noblesse Oblige sopra	60	0,103	0075969				589	630		703	734	749	832	848		
	Open front wall cabinet h. 36 depth 37,8 th. 2,2 Noblesse Oblige above	90	0,139	0075970				633	707		785	827	883	1.007	1.033		
	Haut à jour h. 36 prof. 37,8 ép. 2,2 Noblesse Oblige au-dessus	120	0,184	0075971				677	782		888	939	1.015	1.182	1.217		
D 	Pensile h. 36 prof. 37,8 giorno sp. 2,2 Noblesse Oblige in mezzo	60	0,103	0075972				562	583		594	633	663	718	729		
	Open front wall cabinet h. 36 depth 37,8 th. 2,2 Noblesse Oblige in the middle	90	0,139	0075973				592	633		673	709	753	837	854		
	Haut à jour h. 36 prof. 37,8 ép. 2,2 Noblesse Oblige dans le moyen	120	0,184	0075974				620	684		748	787	844	955	979		
E 	Cappa h. 36 prof. 37,8 giorno sp. 2,2 Noblesse Oblige asp. 1000 m³/h	90	0,139	0075976				2.162	2.235		2.359	2.407	2.412	2.535	2.560		
	Open front hood H. 36 depth 34,8 th. 2,2 Noblesse Oblige 1000 cubic meters	120	0,184	0075977				2.340	2.444		2.598	2.654	2.679	2.845	2.880		
	Hotte à jour H. 36 prof. 34,8 ép. 2,2 Noblesse Oblige asp. 1000 m³/h																
	Kit filtrante per cappa a giorno Noblesse Oblige							124	124		124	124	124	124	124		
	Filter kit for open front hood Noblesse Oblige																
	Kit filtre pour hotte à jour Noblesse Oblige																
F 	Pensile h. 72 prof. 37,8 giorno sp. 2,2 Noblesse Oblige	60	0,182	0075978				909	993		1.082	1.125	1.189	1.328	1.358		
	Open front wall cabinet h. 72 depth 37,8 th. 2,2 Noblesse Oblige	90	0,269	0075979				980	1.119		1.267	1.330	1.414	1.622	1.665		
	Haut à jour h. 72 prof. 37,8 ép. 2,2 Noblesse Oblige	120	0,357	0075980				1.055	1.243		1.402	1.495	1.639	1.915	1.974		
G 	Pensile h. 72 prof. 37,8 giorno sp. 2,2 Noblesse Oblige sopra	60	0,182	0075981				909	993		1.082	1.125	1.189	1.328	1.358		
	Open front wall cabinet h. 72 depth 37,8 th. 2,2 Noblesse Oblige above	90	0,269	0075982				980	1.119		1.267	1.330	1.414	1.622	1.665		
	Haut à jour h. 72 prof. 37,8 ép. 2,2 Noblesse Oblige au-dessus	120	0,357	0075983				1.055	1.243		1.402	1.495	1.639	1.915	1.974		

Elementi speciali mod. Noblesse Oblige

Special furnishing units, mod. Noblesse Oblige
Éléments spéciaux, mod. Noblesse Oblige

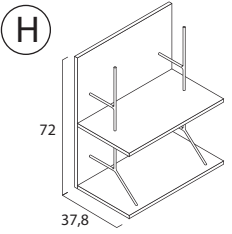
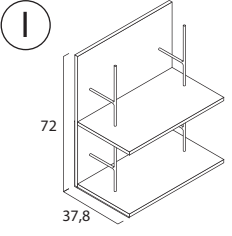
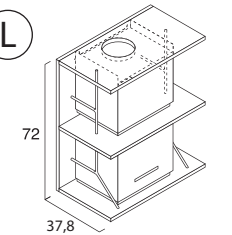
	LARGHEZZA WIDTH LARGEUR	IMBALLO PACKAGE PAQUET	CODICE CODE CODE	CODICE CODE CODE		1	2	3	4	5	6	7	8	9	10	11	12	13	
																			cm
 <p>H Pensile h. 72 prof. 37,8 giorno sp. 2,2 Noblesse Oblige sotto Open front wall cabinet H. 72 depth 37,8 th. 2,2 Noblesse Oblige below Haut à jour H. 72 prof. 37,8 ép. 2,2 Noblesse Oblige ci-dessus</p>	60	0,182	0075984					880	943		1.048	1.089	1.103	1.215	1.238				
	90	0,269	0075985					939	1.045		1.179	1.234	1.284	1.452	1.488				
	120	0,357	0075986					1.000	1.147		1.317	1.388	1.467	1.690	1.738				
 <p>I Pensile h. 72 prof. 37,8 giorno sp. 2,2 Noblesse Oblige in mezzo Open front wall cabinet h. 72 depth 37,8 th. 2,2 Noblesse Oblige in the middle Haut à jour h. 72 prof. 37,8 ép. 2,2 Noblesse Oblige dans le moyen</p>	60	0,182	0075987					880	943		1.048	1.089	1.103	1.215	1.238				
	90	0,269	0075988					939	1.045		1.179	1.234	1.284	1.452	1.488				
	120	0,357	0075989					1.000	1.147		1.317	1.388	1.467	1.690	1.738				
 <p>L Cappa h. 72 prof. 37,8 giorno sp. 2,2 Noblesse Oblige asp. 1000 m³/h Open front hood H. 72 depth 37,8 th. 2,2 Noblesse Oblige 1000 cubic meters Hotte à jour H. 72 prof. 37,8 ép. 2,2 Noblesse Oblige asp. 1000 m³/h</p>	90	0,269	0075938					2.573	2.712		2.905	2.975	3.008	3.214	3.258				
	120	0,357	0075939					2.783	2.972		3.175	3.275	3.367	3.643	3.703				

Pensili finitura foglia oro/argento

con rosa h. 60 - prof. 35,5+anta

Wall cabinets w/gold/silver leaf finishing w/rose decoration h. 60 - d.35,5+door
Hauts avec finition feuille or/argent avec decoration rose h. 60 - prof. 35,5+porte

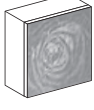
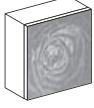
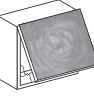
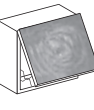
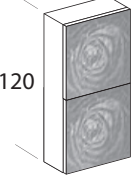
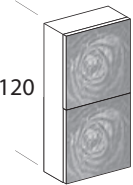
				LARGHEZZA WIDTH LARGEUR	IMBALLO PACKAGE PAQUET	CODICE CODE CODE	CODICE CODE CODE	1	2	3	4	5	6	7	8	9	10	11	12	13	
				cm	m ²	DX RIGHT DROIT	SX LEFT GAUCHE														
	Pensile 1 anta finitura foglia oro con rosa Wall cabinet 1 door with gold leaf finishing with 'rose' decoration Haut 1 porte avec finition feuille or avec décoration 'rose'		opaco	60	0,152	11298	11299					619	619	619	619	619	619	619	619	619	619
			matte	60	0,152	61498	61499						619	619	619	619	619	619	619	619	619
	Pensile 1 anta finitura foglia argento con rosa Wall cabinet 1 door with silver leaf finishing with 'rose' decoration Haut 1 porte avec finition feuille argent avec décoration 'rose'		opaco	60	0,152	11302	11303					619	619	619	619	619	619	619	619	619	619
			matte	60	0,152	61402	61403						619	619	619	619	619	619	619	619	619
	Pensile 1 anta vasistas finitura foglia oro con rosa Wall cabinet 1 door with gold leaf finishing with 'rose' decoration Haut 1 porte avec finition feuille or avec décoration 'rose'		opaco	60	0,152	61324						718	718	718	718	718	718	718	718	718	718
			matte	60	0,152	61424							718	718	718	718	718	718	718	718	718
	Pensile 1 anta vasistas finitura foglia argento con rosa Wall cabinet 1 door with silver leaf finishing with 'rose' decoration Haut 1 porte avec finition feuille argent avec décoration 'rose'		opaco	60	0,152	61326						718	718	718	718	718	718	718	718	718	718
			matte	60	0,152	61426							718	718	718	718	718	718	718	718	718
	Pensile 2 ante H. 60 finitura foglia oro con rosa Wall cabinet 2 doors H. 60 with gold leaf finishing with 'rose' decoration Haut 2 portes H. 60 avec finition feuille or avec décoration 'rose'		opaco	60	0,299	17396	17397					1.234	1.234	1.234	1.234	1.234	1.234	1.234	1.234	1.234	1.234
			matte	60	0,299	17496	17497						1.234	1.234	1.234	1.234	1.234	1.234	1.234	1.234	1.234
	Pensile 2 ante H. 60 finitura foglia argento con rosa Wall cabinet 2 doors H. 60 with silver leaf finishing with 'rose' decoration Haut 2 portes H. 60 avec finition feuille argent avec décoration 'rose'		opaco	60	0,299	17398	17399					1.234	1.234	1.234	1.234	1.234	1.234	1.234	1.234	1.234	1.234
			matte	60	0,299	17498	17499						1.234	1.234	1.234	1.234	1.234	1.234	1.234	1.234	1.234

Scolapiatti finitura foglia oro/argento

con rosa h. 60 - prof. 35,5+anta

Plate drainer w/gold/silver leaf finishing w/rose decoration h. 60 - d.35,5+door
Egouttoir avec finition feuille or/argent avec decoration rose h. 60 - prof. 35,5+porte

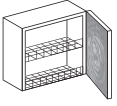
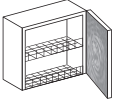
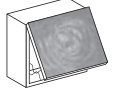
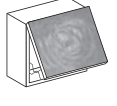
				LARGHEZZA WIDTH LARGEUR	IMBALLO PACKAGE PAQUET	CODICE CODE CODE	CODICE CODE CODE	1	2	3	4	5	6	7	8	9	10	11	12	13	
				cm	m ²	DX RIGHT DROIT	SX LEFT GAUCHE														
	Scolapiatti 1 anta finitura foglia oro con rosa Plate drainer 1 door with gold leaf finishing with 'rose' decoration Egouttoir 1 porte avec finition feuille or avec décoration 'rose'	No push-pull No push-pull Pas de push-pull	opaco	60	0,152	61294	61295					714	714	714	714	714	714	714	714	714	
			matte	60	0,152	61494	61495						714	714	714	714	714	714	714	714	714
	Scolapiatti 1 anta finitura foglia argento con rosa Plate drainer 1 door with silver leaf finishing with 'rose' decoration Egouttoir 1 porte avec finition feuille argent avec décoration 'rose'	No push-pull No push-pull Pas de push-pull	opaco	60	0,152	61296	61297					714	714	714	714	714	714	714	714	714	
			matte	60	0,152	61496	61497						714	714	714	714	714	714	714	714	714
	Scolapiatti 1 anta vasistas finitura foglia oro con rosa Plate drainer 1 door with gold leaf finishing with 'rose' decoration Egouttoir 1 porte avec finition feuille or avec décoration 'rose'	No push-pull No push-pull Pas de push-pull	opaco	60	0,152	61312						814	814	814	814	814	814	814	814	814	
			matte	60	0,152	61412							814	814	814	814	814	814	814	814	814
	Scolapiatti 1 anta vasistas finitura foglia argento con rosa Plate drainer 1 door with silver leaf finishing with 'rose' decoration Egouttoir 1 porte avec finition feuille argent avec décoration 'rose'	No push-pull No push-pull Pas de push-pull	opaco	60	0,140	61314						814	814	814	814	814	814	814	814	814	
			matte	60	0,140	61414							814	814	814	814	814	814	814	814	814



Scolapiatti finitura foglia oro/argento
con rosa h. 60 - prof. 35,5+anta

Plate drainer w/gold/silver leaf finishing w/rose decoration h. 60 - d.35,5+door
Egouttoir avec finition feuille or/argent avec decoration rose h. 60 - prof. 35,5+porte

Pensili finitura foglia oro/argento
con rosa h. 72 - prof. 35,5+anta

Wall cabinets w/gold/silver leaf finishing w/rose decoration h. 72 - d. 35,5+door
Hauts avec finition feuille or/argent avec decoration rose h. 72 - prof. 35,5+porte

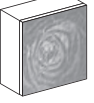
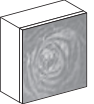
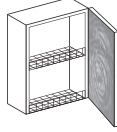
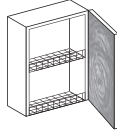
		LARGHEZZA WIDTH LARGEUR	IMBALLO PACKAGE PAQUET	CODICE CODE CODE	CODICE CODE CODE	1	2	3	4	5	6	7	8	9	10	11	12	13
		cm	m ³	DX RIGHT DROIT	SX LEFT GAUCHE													
	Pensile 1 anta finitura foglia oro con rosa	60	0,182	12298	12299					729	729	729	729	729	729	729	729	729
	opaco matt matte lucido	60	0,182	12498	12499					729	729	729	729	729	729	729	729	729
	Pensile 1 anta finitura foglia argento con rosa	60	0,182	12302	12303					729	729	729	729	729	729	729	729	729
	opaco matt matte lucido	60	0,182	12402	12403					729	729	729	729	729	729	729	729	729
		LARGHEZZA WIDTH LARGEUR	IMBALLO PACKAGE PAQUET	CODICE CODE CODE	CODICE CODE CODE	1	2	3	4	5	6	7	8	9	10	11	12	13
		cm	m ³	DX RIGHT DROIT	SX LEFT GAUCHE													
	Scolapiatti 1 anta finitura foglia oro con rosa	60	0,182	12294	12295					825	825	825	825	825	825	825	825	825
	opaco matt matte lucido	60	0,182	12494	12495					825	825	825	825	825	825	825	825	825
	Scolapiatti 1 anta finitura foglia argento con rosa	60	0,182	12296	12297					825	825	825	825	825	825	825	825	825
	opaco matt matte lucido	60	0,182	12496	12497					825	825	825	825	825	825	825	825	825

Basi speciali Domina con fianco h. 72 con zoccolo, senza top, solo con struttura Bianco

Domina special base units with side h. 72 with plinth, without top, only with White colour structure
Bases spéciales Domina avec côté h. 72 socle, sans dessus, seulement avec structure couleur Blanc

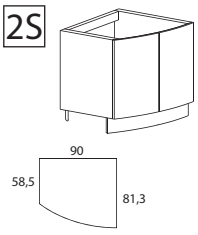
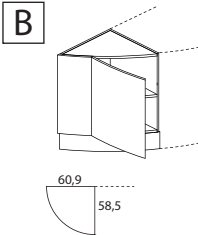
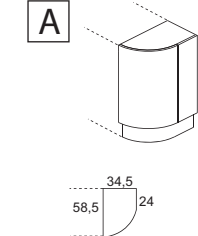
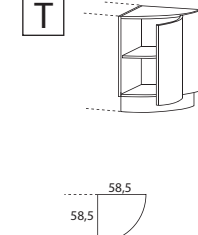
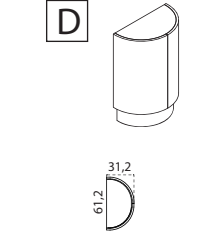
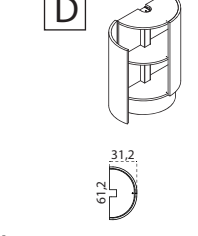
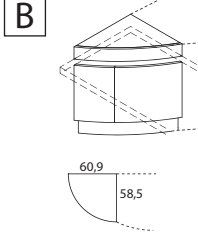
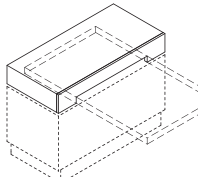
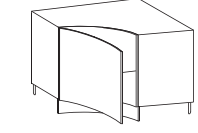
		LARGHEZZA WIDTH LARGEUR	IMBALLO PACKAGE PAQUET	CODICE CODE CODE	CODICE CODE CODE	1	2	3	4	5	6	7	8	9	10	11	12	13
		cm	m ³	DX RIGHT DROIT	SX LEFT GAUCHE													
 <p>2S Base stondata Domina 2 ante per elemento 180 Round shaped base Domina 2 doors for 180 cm round unit Base arrondie Domina 2 portes pour élément 180</p>		90	0,573	02020	02021					1.084	1.125	1.282	1.670	1.797	1.938	2.340	2.765	
	Per piano cottura For hob Pour plaque	90	0,573	03020	03021					1.084	1.125	1.282	1.670	1.797	1.938	2.340	2.765	
	Per lavello(fondo acciaio) For sink(st. steel bottom) Pour évier(fond en acier)	90	0,573	04130	04131					1.112	1.153	1.312	1.698	1.825	1.965	2.369	2.794	
 <p>B Base terminale rotonda Domina, 1 anta, 1 fascia (B) Rounded end base Domina, 1 door, 1 filler (B) Base terminale arrondie Domina, 1 porte, 1 bande (B)</p>		60,9	0,275	02080	02081					967	998	1.125	1.405	1.512	1.770	2.174	2.598	
 <p>A Base terminale rotonda h.72, 1 anta Rounded end base h. 72, 1 door Base terminale arrondie h. 72, 1 porte</p>		34,5	0,164	01580	01581					665	665	757	937	1.008	1.234	1.483	1.808	
 <p>T Base terminale rotonda h.72, 1 anta rotonda, 1 anta fissa (T) Rounded end base h. 72, 1 door, 1 filler (T) Base terminale arrondie h. 72, 1 porte ronde, 1 bande (T)</p>		58,5	0,271	01582	01583					999	1.030	1.150	1.439	1.548	1.803	2.207	2.632	
 <p>D Base terminale penisola 2 ante curve (D) Peninsula end base 2 round doors (D) Base terminale 2 portes rondes (D)</p>		61,2	0,143	01506						1.344	1.395	1.544	1.940	2.085	2.234	2.635	3.062	
 <p>D Base terminale penisola 2 ante curve con supporto centrale per piano tondo Ø 126 (D) 2 round doors peninsula end base with central support for round plane Ø126 (D) Base terminale 2 portes rondes avec support central pour plan rond Ø126 (D)</p>		61,2	0,143	01547						1.798	1.873	2.014	2.413	2.594	2.703	3.103	3.532	
 <p>B Base terminale per innesto penisola 1 anta h. 54 * fascia fissa, riempimento h. 12 (B) (altezza variabile in funzione dello spessore top, riempimento h. 12 = top sp. 6) End base for peninsula set up 1 door h. 54 + fixed filler, filling h. 12 (B) (height changes according to worktop thickness, filling h. 12 = top th. 6) Base terminale pour établissement de la péninsule, 1 porte h. 54 + bande, remplissage h. 12 (B) (hauteur variant en fonction du épaisseur du plan de travail, remplissage h. 12 = plan de travail ép. 6)</p>		60,9	0,278	01544	01545					1.299	1.328	1.509	1.734	1.864	2.318	2.843	3.408	
 <p>Riempimento h. 18 per innesto penisola su basi h. 54 Filling h. 18 for peninsula set up on bases h. 54 Remplissage h. 18 pour établissement de la péninsule sur bases h. 54</p>		120	0,100	01546						373	400	459	467	503	527	550	610	
 <p>Base angolo curva Domina 1 anta Corner base Domina with 1 round door Base pour angle Domina, avec 1 porte ronde</p> <p>N.B.: ammortizzazione con pistoncino Soft-closing system with piston Mecanisme amortisé avec piston</p>	Per piano cottura For hob Pour plaque	90x90	0,635	01676	01677					1.578	1.628	1.755	2.032	2.184	2.049	2.245	2.463	
		90x90	0,635	01682	01683					1.578	1.628	1.755	2.032	2.184	2.049	2.245	2.463	
	Per lavello For sink Pour évier	90x90	0,635	01684	01685					1.649	1.699	1.825	2.102	2.260	2.120	2.314	2.534	
	Magg. fondo inox Inc. st. steel bottom aug. Fond acier				4403071					293	293	293	293	293	293	293	293	293

Colonne e sopracolonne speciali Domina solo con struttura Bianco

Domina special columns and top column units only with White colour structure
Colonne et sur-colonnes spéciaux Domina seulement avec structure couleur Blanc

LARGHEZZA WIDTH LARGEUR	IMBALLO PACKAGE PAQUET	CODICE CODE CODE	CODICE CODE CODE	1	2	3	4	5	6	7	8	9	10	11	12	13
cm	m ³	DX RIGHT DROIT	SX LEFT GAUCHE													

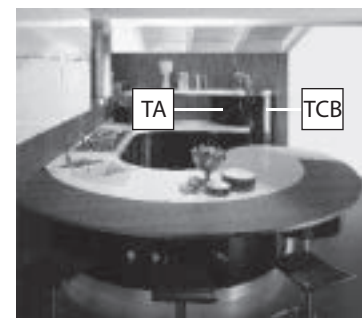
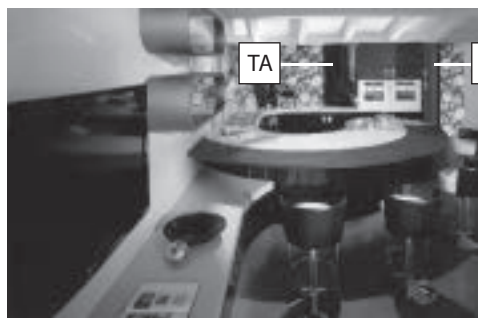

TA	Elemento appoggio Domina h. 56, 1 anta h. 36 + 1 cassetto h. 20 (altezza variabile in funzione dello spessore del top, cassetto h. 20 = top sp. 4) (T)	Cassetto no push-pul no Blumotion Drawer no push-pull no Blumotion Tiroir pas de push-pull pas de Blumotion	58,5	0,212	31482	31483					607	619	705	890	958	1.368	1.733	2.155	
	On-top round unit Domina h. 56, 1 door h. 36 + 1 drawer h. 20, height variable according to worktop thickness, drawer 20 = top th. 4) (T) Élément soutien Domina h. 56, 1 porte h. 36 + 1 tiroir h. 20, (hauteur variant en fonction du épaisseur du plan de travaille, tiroir h. 20 = plan de travaille ép. 4) (T)																		
Disegno sx - left drawing - dessin gauche																			
TCB	Colonna terminale Domina h. 147, (fianco 132), 1 anta rotonda (T)		58,5	0,545	31484	31485					1.084	1.128	1.262	1.534	1.650	2.237	2.638	3.339	
	End column unit Domina h. 147 (side 132), 1 round door (T) Colonne terminale Domina h. 147 (côté 132), 1 porte ronde (T)																		
Disegno dx - right drawing - dessin droit																			
TC	Colonna terminale Domina h. 219, (fianco 204), 2 ante rotonde (T) inferiore 132, superiore 72	Inferiore 72, superiore 132 Lower 72, upper 132 Inférieur 72, supérieur 132	58,5	0,808	31486	31487					1.722	1.789	1.949	2.302	2.475	3.622	4.428	5.552	
	End column unit Domina h. 219 (side 204), 2 round doors(T) lower 132, upper 72 Colonne terminale Domina h. 219 (côté 204), 2 portes ronde (T) inférieur 132, supérieur 72																		
Disegno dx - right drawing - dessin droit																			
	Colonna h. 210, 2 ante bombate, con ripiani	Solo laccato Only lacquered Seulement laqué	60	0,746	27140	27141					1.314	1.469	1.588						
	Column h. 201, 2 round doors with shelves Colonne h. 201, 2 portes bombées avec étagères Per apertura corretta (110°) l'anta bombata deve avere uno spazio di 15 cm sul lato di apertura For correct opening (110°) the rounded door has to have a space of 15 cm. on the opening side Pour une correcte ouverture (110°) la porte arrondie doit avoir un espace de 15 cm. sur le côté d'ouverture																		
Disegno dx - right drawing - dessin droit																			
	Colonna h. 219 per frigo freezer 2 ante bombate	Solo laccato Only lacquered Seulement laqué	60	0,818	30050	30051					1.228	1.493	1.584						
	Column h. 219 for fridge/freezer, 2 round doors Colonne h. 219 pour réfrigérateur/ congélateur 2 portes bombées Per apertura corretta (110°) l'anta bombata deve avere uno spazio di 15 cm sul lato di apertura For correct opening (110°) the rounded door has to have a space of 15 cm. on the opening side Pour une correcte ouverture (110°) la porte arrondie doit avoir un espace de 15 cm. sur le côté d'ouverture	Cerniere ammortizzate solo su anta superiore Soft closing hinge only on upper door Charnière amortizé seulement sur porte supérieure Push-pull solo con anta staccata da elettrodomestico Push-pull opening system available only if the door is not sticked to fridge door Avec ouverture push-pull seulement si la porte n'est pas fixée à la porte du réfrigérateur																	
Disegno dx - right drawing - dessin droit																			
	Colonna h. 219 per frigo combi 2 ante bombate	Solo laccato Only lacquered Seulement laqué	60	0,818	30060	30061					1.272	1.508	1.598						
	Column h. 219 for combi fridge, 2 round doors Colonne h. 219 pour réfrigérateur combi 2 portes bombées Per apertura corretta (110°) l'anta bombata deve avere uno spazio di 15 cm sul lato di apertura For correct opening (110°) the rounded door has to have a space of 15 cm. on the opening side Pour une correcte ouverture (110°) la porte arrondie doit avoir un espace de 15 cm. sur le côté d'ouverture	No cerniere ammortizzate No soft closing hinge Pas de charnière amortizée Push-pull solo con anta staccata da elettrodomestico Push-pull opening system available only if the door is not sticked to fridge door Avec ouverture push-pull seulement si la porte n'est pas fixée à la porte du réfrigérateur																	



Tavoli

Tables
Tables

DIM. PIANA TOP WIDTH DIM. PLANE	CODICE CODE CODE	PREZZO PRICE PRIX
cm		

Tavoli

Tables
Tables

DIM. PIANA TOP WIDTH DIM. PLANE	CODICE CODE CODE	PREZZO PRICE PRIX
cm		



Legenda tavoli e sedie Legend tables and chairs Indications tables au chaises



A
D

ATELIER
DOMINA

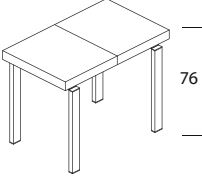
C
N

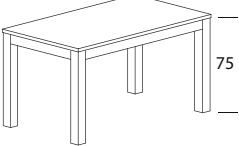
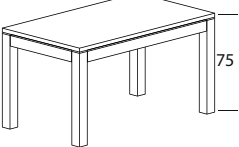
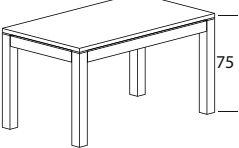
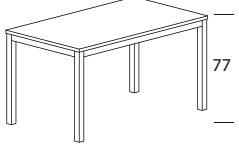
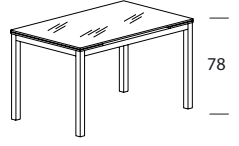
CONTEMPORA
NOBLESSE

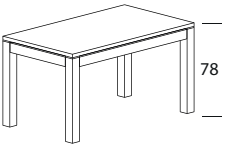
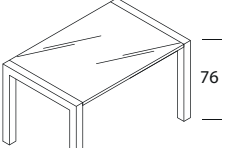
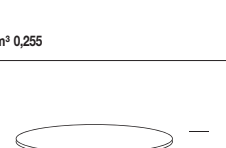
	Tavolo Trendy allungabile in noce naturale (n. 3 allunghi) Extensible table Trendy natural walnut, n. 3 extensions Table Trendy allongeable, en noix naturelle (n. 3 étendues)		160(300)x90	0070261	3.402	m ³ 0,225
	Tavolo Moon allungabile, gambe a castello alluminio satinato, piana vetro Extensible table Moon, glass top, base and legs mat aluminium Table Moon allongeable, jambes et chateau aluminium satiné, plan en verre		160(220)x90	0070256	3.222	m ³ 0,290
	Tavolo Moon allungabile, gambe e castello cromo, piana vetro Extensible table Moon, glass top, base and legs chromium Table Moon allongeable, jambes et chateau chrome, plan en verre		160(220)x90	0070338	3.462	m ³ 0,290
	Tavolo Kubo allungabile, basamento e gambe faggio tinto noce, piana noce Trendy Extensible table Kubo, walnut top, base and legs beech walnut colour Table Kubo allongeable, base et jambes en hêtre teinte noix, plan en noix		160(210)x90	0070257	1.053	m ³ 0,290
	Tavolo Logico allungabile, gambe tinto rovere, piana impiallacciata rovere Extensible table Logico, oak coloured legs, veneered oak top Table Logico allongeable, jambes teintées rouvre, plan plaqué rouvre	rovere naturale rovere wengè rovere moro rovere grigio	130(200)x85 130(200)x85 130(300)x85 130(300)x85	0070263 0070264 0070419 0070420	1.497 1.629 1.629 1.629	m ³ 0,215
	Tavolo Logico allungabile, gambe tinto rovere, piana impiallacciata rovere Extensible table Logico, oak coloured legs, veneered oak top Table Logico allongeable, jambes teintées rouvre, plan plaqué rouvre	rovere naturale rovere wengè rovere moro rovere origgio	200(300)x90 200(300)x90 200(300)x90 200(300)x90	0070265 0070266 0070421 0070422	2.094 2.189 2.189 2.189	m ³ 0,360
	Tavolo Zen allungabile, gambe e castello in metallo, piana in laminato bianco Extensible table Zen, base and legs metal coated grey, top lam. White Table Zen allongeable, jambes et chateau en métal, plan laminé blanc		140(188)x80	0070192	617	m ³ 0,225
	Tavolo Aliante allungabile, gambe e castello in alluminio satinato, piana in vetro Extensible table Aliante, glass top, base and legs sat. Aluminium Table Aliante allongeable, jambes et chateau aluminium satiné, plan en verre		130(190)x80	0070194	1.518	m ³ 0,210

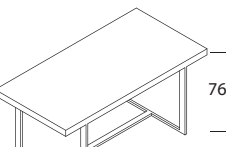
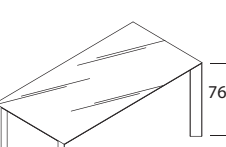
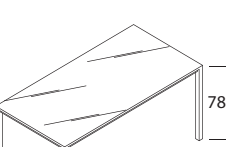
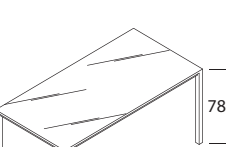
	Tavolo Cartesio allungabile, gambe e piano in legno tinto ciliegio Time Extensible table Cartesio, top and base cherry veneered, cherry colour legs Time Table Cartesio allongeable, jambes et plan en bois teint cerisier Time		140(180)x80	0070200	939	m ³ 0,225
	Tavolo Mercurio allungabile, telaio alluminio, piana in vetro bianco Extensible table Mercurio, aluminium frame, white glass top Table Mercurio allongeable, cadre en aluminium, plan en verre blanche		140(196)x90	0070339	1.114	m ³ 0,255
	Tavolo Mercurio allungabile, telaio alluminio, piana in vetro nero Extensible table Mercurio, aluminium frame, black glass top Table Mercurio allongeable, cadre en aluminium, plan en verre noir		140(196)x90	0070341	1.114	m ³ 0,255
	Tavolo Planet, diametro 120 struttura e piana bianco laccato Table Planet, diameter 120, white laquered structure and top Table Planet, diamètre 120, structure et plan blanc laqué		Ø 120	0070346	1.197	m ³ 0,290
	Tavolo Planet, diametro 120, struttura cromo, piana in vetro satinato Table Planet, diameter 120, chrome structure, glazed glass top Table Planet, diamètre 120, structure chrome, plan en verre satiné		Ø 120	0070347	1.210	m ³ 0,290
	Tavolo Tecno allungabile, gambe cromo e piano impiallacciato Extensible table Tecno, chrome legs and veneered top Table Tecno extensible avec structure chromé et plane plaqué	rovere naturale rovere ciliegio rovere ciliegio scuro rovere wengè rovere panna rovere rosso rovere antracite rovere moro canaletto opaco	180(300)x100 180(300)x100 180(300)x100 180(300)x100 180(300)x100 180(300)x100 180(300)x100 180(300)x100 180(300)x100	0070374 0070375 0070376 0070377 0070378 0070379 0070380 0070381 0070382	3.090 3.090 3.090 3.090 3.090 3.090 3.090 3.090 3.090	m ³ 0,325
	Tavolo Concept allungabile, struttura alluminio verniciato e piano sp. 6 vetro Extensible table Concept with aluminium structure and glass top th. 6 Table Concept extensible avec structure en aluminium et plan verre ép. 6	bianco nero	160(220)x90 160(220)x90	0070383 0070423	1.725 1.725	m ³ 0,290
	Tavolo Flux allungabile, struttura cromo e piano vetro verniciato Extensible table Flux chrome structure and painted glass top Table Flux extensible avec structure chromé et plan en verre	nero bianco moka	180(280)x90 180(280)x90 180(280)x90	0070384 0070385 0070386	4.389 4.389 4.389	m ³ 0,325
	Tavolo Flux allungabile, struttura cromo e piano vetro verniciato Extensible table Flux chrome structure and painted glass top Table Flux extensible avec structure chromé et plan en verre	nero bianco moka	140(200)x80 140(200)x80 140(200)x80	0070387 0070388 0070389	3.172 3.172 3.172	m ³ 0,225

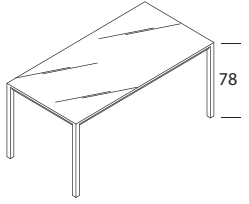
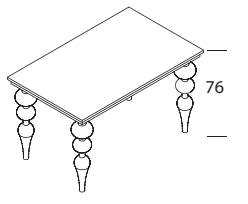
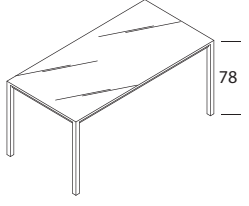
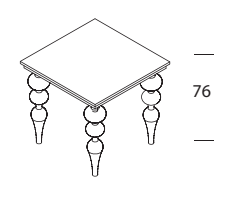
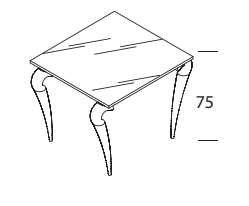
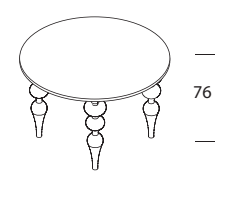
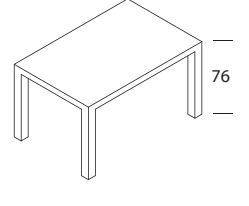
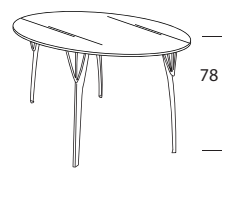
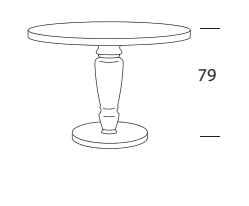
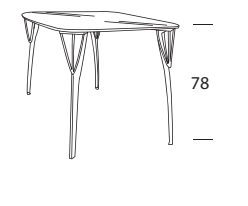
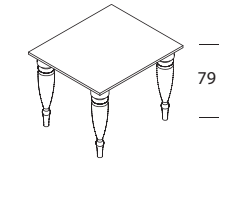
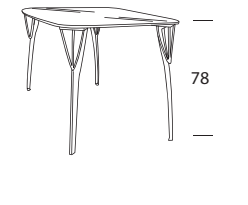
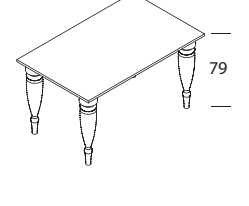
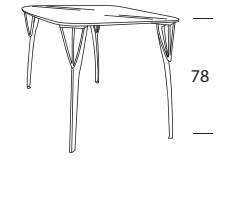
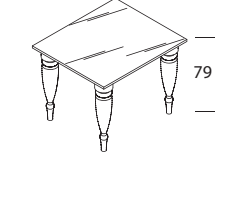
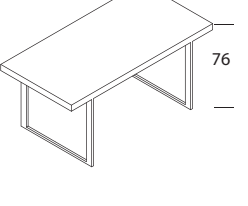
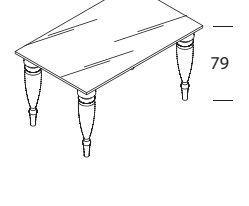
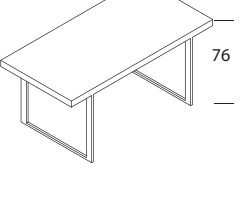

Tavoli

Tables
Tables

		DIM. PIANA TOP WIDTH DIM. PLANE	CODICE CODE CODE	PREZZO PRICE PRIX	Tavoli		DIM. PIANA TOP WIDTH DIM. PLANE	CODICE CODE CODE	PREZZO PRICE PRIX	
		cm			Tables Tables		cm			
 <p>Tavolo Flux allungabile, struttura laccata e piano vetro verniciato</p> <p>Extensible table Flux, lacquered structure and painted glass top</p> <p>Table Flux extensible à rallonges structure laqué et plan en verre peint</p>	nero	180(280)x90	0070348	4.325	 <p>Tavolo Glamour allungabile, gambe tornite e piano laccato</p> <p>Extensible table Glamour, lacquered turned legs and top</p> <p>Table Glamour extensible avec pieds modélés et plan laqué</p>	bianco	160(210)x90	0070416	2.293	
	bianco	180(280)x90	0070349	4.325		nero	160(210)x90	0070417	2.293	
	moka	180(280)x90	0070350	4.325						
m ³ 0,325					m ³ 0,290					
 <p>Tavolo Flux allungabile, struttura laccata e piano vetro verniciato</p> <p>Extensible table Flux, lacquered structure and painted glass top</p> <p>Table Flux extensible à rallonges structure laqué et plan en verre peint</p>	nero	140(200)x80	0070351	3.127	 <p>Tavolo Glamour fisso, gambe tornite e piano laccato</p> <p>Table Glamour, lacquered turned legs and top</p> <p>Table Glamour avec pieds modélés et plan laqué</p>	bianco	118x118	0070446	1.580	
	bianco	140(200)x80	0070352	3.127		nero	118x118	0070447	1.580	
	moka	140(200)x80	0070353	3.127						
m ³ 0,225					m ³ 0,290					
 <p>Tavolo Elegance, gambe tornite finitura oro o argento, piano cristallo sp. 1,9</p> <p>Table Elegance with turned legs gold or silver, glass top th. 1,9</p> <p>Table Elegance avec pieds modélés or au argent et plan en crystal ép. 1,9</p>	gambe oro	130x130	0070390	4.313	 <p>Tavolo Glamour allungabile, gambe tornite e piano laccato</p> <p>Extensible table Glamour, lacquered turned legs and top</p> <p>Table Glamour extensible avec pieds modélés et plan laqué</p>	bianco	Ø120 (157)	0070448	2.338	
	gambe argento	130x130	0070391	4.313		nero	Ø120 (157)	0070449	2.338	
m ³ 0,340					m ³ 0,290					
 <p>Tavolo Agorà, struttura e piano impiallacciato rovere</p> <p>Table Agorà, oak veneered structure and top</p> <p>Table Agorà structure et plan plaqué chêne</p>	wengè	150(306)x90	0070392	2.653	 <p>Tavolo Stelo, struttura cromo, piano vetro trasparente</p> <p>Table Stelo, chrome structure and transparent glass top</p> <p>Table Stelo, structure chromé et plan en verre transparent</p>		Ø 130	0070354	3.082	
	moro	150(306)x90	0070393	2.888						
	grigio	150(306)x90	0070394	2.888						
	naturale	150(306)x90	0070395	2.653						
m ³ 0,270					m ³ 0,340					
 <p>Tavolo Paris, gambe tornite e piano laccato lucido</p> <p>Table Paris, turned legs and top lacquered</p> <p>Table Paris avec pied modèlé et plan laqué</p>	bianco lucido	Ø 120	0070396	2.189	 <p>Tavolo Stelo, struttura cromo, piano vetro trasparente</p> <p>Table Stelo, chrome structure and transparent glass top</p> <p>Table Stelo, structure chromé et plan en verre transparent</p>		165x88	0070355	2.913	
	nero lucido	Ø 120	0070397	2.189						
m ³ 0,290					m ³ 0,295					
 <p>Tavolo Fleur, gambe tornite e piano laccato lucido</p> <p>Table Fleur, turned legs and top lacquered</p> <p>Table Fleur avec pied modèlé et plan laqué</p>	bianco lucido	140x140	0070398	3.090	 <p>Tavolo Stelo, struttura cromo, piano impiallacciato rovere</p> <p>Table Stelo, chrome structure and oak veneered top</p> <p>Table Stelo, structure chromé et plan plaqué chêne</p>	naturale	165x88	0070356	2.885	
	nero lucido	140x140	0070399	3.090		tinto ciliegio	165x88	0070357	2.885	
						tinto ciliegio scuro	165x88	0070358	2.885	
						tinto wengè	165x88	0070359	2.885	
						panna	165x88	0070360	2.885	
						rosso	165x88	0070361	2.885	
						antracite	165x88	0070362	2.885	
						moro	165x88	0070363	2.885	
	m ³ 0,390					m ³ 0,295				
	 <p>Tavolo Fleur, gambe tornite e piano laccato lucido</p> <p>Table Fleur, turned legs and top lacquered</p> <p>Table Fleur avec pied modèlé et plan laqué</p>	bianco lucido	200x100	0070402		2.962	 <p>Tavolo Stelo, struttura cromo, piano impiallacciato rovere</p> <p>Table Stelo, chrome structure and oak veneered top</p> <p>Table Stelo, structure chromé et plan plaqué chêne</p>	naturale	131x79	0070364
nero lucido		200x100	0070403	2.962	tinto ciliegio	131x79		0070365	2.679	
					tinto ciliegio scuro	131x79		0070366	2.679	
					tinto wengè	131x79		0070367	2.679	
					panna	131x79		0070368	2.679	
					rosso	131x79		0070369	2.679	
					antracite	131x79		0070370	2.679	
					moro	131x79		0070371	2.679	
m ³ 0,400					m ³ 0,210					
 <p>Tavolo Fleur, gambe tornite laccate lucide, piano vetro sp. 1,5</p> <p>Table Fleur, lacquered turned legs and glass top th. 1,5</p> <p>Table Fleur avec pieds modélés laqué et plan en verre ép. 1,5</p>		bianco lucido	140x140	0070404	2.692	 <p>Tavolo Polo fisso, basamento in alluminio goffrato, piana laminato</p> <p>Table Polo, fixed support structure in matt aluminium, laminate top</p> <p>Table Polo, fixe support en aluminium opaque, plan laminé</p>		wengè	140x90	0070425
	nero lucido	140x140	0070405	2.692	bianco		140x90	0070426	822	
	foglia oro	140x140	0070406	3.004	noce		140x90	0070427	822	
	foglia argento	140x140	0070407	3.004	rovere grigio		140x90	0070428	822	
m ³ 0,390				m ³ 0,255						
 <p>Tavolo Fleur, gambe tornite laccate lucide, piano vetro sp. 1,5</p> <p>Table Fleur, lacquered turned legs and glass top th. 1,5</p> <p>Table Fleur avec pieds modélés laqué et plan en verre ép. 1,5</p>	bianco lucido	200x100	0070412	2.702	 <p>Tavolo Polo fisso, basamento in alluminio cromato, piana laminato</p> <p>Table Polo, fixed support structure in chromed aluminium, laminate top</p> <p>Table Polo, fixe support en aluminium chromé, plan laminé</p>	wengè	140x90	0070429	1.404	
	nero lucido	200x100	0070413	2.702		bianco	140x90	0070430	1.404	
	foglia oro	200x100	0070414	3.008		noce	140x90	0070431	1.404	
	foglia argento	200x100	0070415	3.008		rovere grigio	140x90	0070432	1.404	
m ³ 0,400				m ³ 0,255						

Scolapiatti h. 96 - prof. 35,5+anta

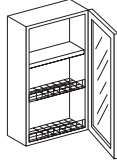
Plate drainers h. 96 - depth 35,5+door
Egouttoir h. 96 - prof. 35,5+porte

	LARGHEZZA WIDTH LARGEUR	IMBALLO PACKAGE PAQUET	CODICE CODE CODE	CODICE CODE CODE	VT01	VT02	VT03	VT04	VT05	VT06	VT07	VT08	VT09	VT10	VT11
 <p>Scolapiatti 1 anta vetro Plate drainer 1 glass door Egouttoir 1 porte en verre</p>															
	<p>No push-pull No push-pull Pas de push-pull</p> <p>N.B.: ripiani vetro glass shelves étagères en verre</p>	45 60	0,182 0,241	16230 16234	16231 16235	837 879	857 919	1.010 1.097	1.128 1.253	1.624 1.634	1.914 1.923	1.368 1.378	1.564 1.573	1.682 1.692	1.252 1.265
 <p>Scolapiatti 2 ante vetro Plate drainer 2 glass doors Egouttoir 2 portes en verre</p>															
	<p>No push-pull No push-pull Pas de push-pull</p> <p>N.B.: ripiani vetro glass shelves étagères en verre</p>	90	0,357	16240		939	979	1.287	1.522	2.514	3.094	2.002	2.394	2.629	1.769

Pensili h. 120 - prof. 35,5+anta

Wall cabinets h. 120 - depth 32,5+door
Hauts h. 120 - prof. 32,5+porte

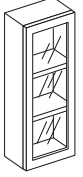
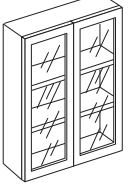
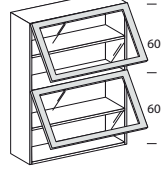
	LARGHEZZA WIDTH LARGEUR	IMBALLO PACKAGE PAQUET	CODICE CODE CODE	CODICE CODE CODE	VT01	VT02	VT03	VT04	VT05	VT06	VT07	VT08	VT09	VT10	VT11
 <p>Pensile 1 anta vetro Wall cabinet 1 glass door Haut 1 porte en verre</p>															
	<p>N.B.: ripiani vetro glass shelves étagères en verre</p>	45 60	0,227 0,299	17140 17144	17141 17145	1.022 1.080	1.028 1.084	1.193 1.308	1.339 1.503	1.782 1.789	2.159 2.165	1.528 1.535	1.738 1.745	1.894 1.902	1.377 1.417
 <p>Pensile 2 ante vetro Wall cabinet 2 glass doors Haut 2 portes en verre</p>															
	<p>N.B.: ripiani vetro glass shelves étagères en verre</p>	90	0,444	17150		1.403	1.415	1.745	2.038	2.923	3.678	2.415	2.835	3.148	2.113
 <p>Pensile 2 ante h. 60 vetro a Vasistas Wall cabinet 2 glass door h. 60 Haut 2 portes h. 60 en verre à Vasistas</p>															
	<p>N.B.: ripiani vetro glass shelves étagères en verre</p>	90	0,444	17697		1.480	1.515	1.923	2.215	2.988	3.755	2.475	2.905	3.290	

Scolapiatti h. 120 - prof. 35,5+anta

Plate drainers h. 120 - depth 35,5+door
Egouttoir h. 120 - prof. 35,5+porte

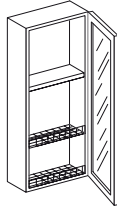
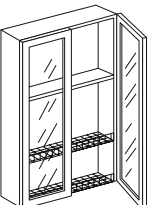
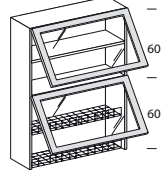
	LARGHEZZA WIDTH LARGEUR	IMBALLO PACKAGE PAQUET	CODICE CODE CODE	CODICE CODE CODE	VT01	VT02	VT03	VT04	VT05	VT06	VT07	VT08	VT09	VT10	VT11
 <p>Scolapiatti 1 anta vetro Plate drainer 1 glass door Egouttoir 1 porte en verre</p>															
	<p>No push-pull No push-pull Pas de push-pull</p> <p>N.B.: ripiani vetro glass shelves étagères en verre</p>	45 60	0,227 0,299	17230 17234	17231 17235	1.115 1.177	1.122 1.180	1.287 1.404	1.433 1.599	1.875 1.885	2.253 2.262	1.622 1.632	1.832 1.842	1.988 1.998	1.470 1.513
 <p>Scolapiatti 2 ante vetro Plate drainer 2 glass doors Egouttoir 2 portes en verre</p>															
	<p>No push-pull No push-pull Pas de push-pull</p> <p>N.B.: ripiani vetro glass shelves étagères en verre</p>	90	0,444	17242		1.527	1.539	1.869	2.162	3.047	3.802	2.539	2.959	3.272	2.237
 <p>Scolapiatti 2 ante h. 60 vetro a Vasistas Plate drainer 2 lift-up glass door h. 60 Egouttoir 2 portes h. 60 en verre à Vasistas</p>															
	<p>N.B.: ripiani vetro glass shelves étagères en verre</p>	90	0,444	17797		1.605	1.640	2.048	2.340	3.113	3.880	2.600	3.030	3.415	

Maggiorazione per finitura fianchi a vista prof. 56,2

Supplement for visible side panels depth 56,2
Majoration pour finissage cotés à vue prof. 56,2

Legenda finiture fianchi a vista

Legend to the chart of visible side panels
Indications pour finissage cotés à vue

A_ Polimerico

B_ Atelier Laccato Opaco

C_ Laminato

D_ Atelier Laccato Lucido

E_ Rovere

F_ Laccato Opaco

G_ Laccato Lucido

H_ Legni Speciali Opachi

I_ Laccato Metallizzato / Cemento

L_ Legni Speciali Opachi 2

M_ Legni Speciali Lucidi 1

N_ Legni Speciali Lucidi 2

O_ Legni Speciali Opachi 3

P_ Foglia Oro/Arg Opaco

Q_ Foglia Oro/Arg Lucido

R_ Legni Speciali Lucidi 3

Z_ Massello castagno

Polimeryc

Atelier matt lacquered

Laminate

Atelier glossy lacquered

Oak

Matt lacquered

Glossy lacquered

Matt special woods 1

Metallic glossy lacquered/Cemento

Matt special woods 2

Glossy special woods 1

Glossy special woods 2

Matt special woods 3

Gold /Silver leaf matt

Gold /Silver leaf glossy

Glossy special woods 3

Solid Chestnut

Polimère

Atelier laqué opaque

Laminé

Atelier laqué brillant

Chêne

Laqué opaque

Laqué brillant

Bois spéciaux opaques 1

Laqué métallisé/Ciment

Bois spéciaux opaques 2

Bois spéciaux brillants 1

Bois spéciaux brillants 2

Bois spéciaux opaques 3

Or/argent feuille opaque

Or/argent feuille brillant

Bois spéciaux brillants 3

Chataignier Massif

		altezza height hauteur	A	B	C	D	E	F	G	H	I	L	M	N	O	P	Q	R	Z
BASI base unit bases	54				85		52	49	88	127	118	142	155	167	268	124	137	295	199
	60		39	47	95	88	58	54	97	142	132	157	174	187	295	138	150	329	218
	72		45	52	99	103	62	58	114	157	155	174	189	203	328	165	183	355	252
	84				104		70	67	129	182	182	208	218	234					287
	87*		57	64	107	123	73	69	135	188	189	214	225	242	335	200	220	373	294
	92*			64	117		79	75	148	204	205	234	245	264					310
PENSILI wall cabinets hauts	24		15	17	22	27	20	18	29	40	38	54	50	54	85	50	64	97	79
	36		19	23	33	33	24	24	35	63	50	82	73	78	134	58	77	144	102
	54				45		29	29	53	82	70	92	97	104	168	77	98	182	133
	60		27	29	50	52	33	33	60	92	78	102	107	114	187	85	110	202	143
	72		30	32	57	62	37	34	67	102	92	114	129	140	220	98	110	245	163
	96		39	42	65	88	52	47	98	133	135	149	157	168	278	124	152	305	205
120		50	53	82	110	65	60	115	165	169	187	197	210	348	155	190	382	260	
COLONNE PROF. 35,2 columns depth 35,2 colonnes prof. 35,2	96		39	42	65	88	52	47	98	133	135	149	157	168	278	124	152	305	205
	132		45	59	98	107	67	64	118	179	159	185	214	230	323	165	179	355	282
	144				110		75	72	133	200	180	208	240	258					304
	186				139		93	88	163	249	232	260	299	322	454	232	250	495	394
	192		65	77	144	153	97	90	168	258	239	270	310	333	468	239	258	510	407
	204		70	85	177	163	102	95	180	273	252	279	330	355	552	247	294	593	433
216				193		112	104	197	297	277	305	360	387					455	
COLONNE PROF. 56,2 columns depth 56,2 colonnes prof. 56,2	96		58	65	109	135	80	72	149	199	212	232	242	260	437	234	247	463	323
	132		58	65	109	183	112	103	149	282	282	273	348	373	573	260	329	625	449
	144		83	94	170		125	117	202	317	317	307	392	420					485
	186				193		152	137	228	369	397	369	450	484	750	342	423	829	644
	192				250	260	157	142	279	382	407	382	464	499	775	354	439	857	665
	204		123	125	260	283	163	147	288	383	433	397	467	502	858	464	505	927	702
216		132	133	262		179	159	312	418	470	434	509	548					740	
228				285	313	192	174	340	427	484	505	523	562	968	479	573	1.049	777	
SOPRALZO top column surélévation	24		19	19	22	42	27	20	47	72	67	90	84	92	152	58	70	165	113
	36		24	25	55	57	30	27	62	102	79	124	122	132	185	75	90	220	148
	54				85		49	49	88	127	118	142	155	167	268	124	137	295	199
	60		42	47	97	88	54	54	97	142	132	157	174	187	295	138	150	329	218

* per fianco finale laterale vedi pag. 84, pag. 96

pour coté final lateral voir pag.84, pag. 96

for additional side panel see pag.84, pag. 96



Maggiorazione per finitura fianchi a vista prof. 61

Supplement for visible side panels depth 61
Majoration pour finissage cotés à vue prof. 61

Legenda finiture fianchi a vista

Legend to the chart of visible side panels
Indications pour finissage cotés à vue

A_ Polimerico
B_ Atelier Laccato Opaco
C_ Laminato
D_ Atelier Laccato Lucido
E_ Rovere
F_ Laccato Opaco
G_ Laccato Lucido
H_ Legni Speciali Opachi
I_ Laccato Metallizzato / Cemento
L_ Legni Speciali Opachi 2
M_ Legni Speciali Lucidi 1
N_ Legni Speciali Lucidi 2
O_ Legni Speciali Opachi 3
P_ Foglia Oro/Arg Opaco
Q_ Foglia Oro/Arg Lucido
R_ Legni Speciali Lucidi 3
Z_ Massello castagno

Polimeryc
Atelier matt lacquered
Laminate
Atelier glossy lacquered
Oak
Matt lacquered
Glossy lacquered
Matt special woods 1
Metallic glossy lacquered/Cement
Matt special woods 2
Glossy special woods 1
Glossy special woods 2
Matt special woods 3
Gold /Silver leaf matt
Gold /Silver leaf glossy
Glossy special woods 3
Solid Chestnut

Polimère
Atelier laqué opaque
Laminé
Atelier laqué brillant
Chêne
Laqué opaque
Laqué brillant
Bois spéciaux opaques 1
Laqué métallisé/Ciment
Bois spéciaux opaques 2
Bois spéciaux brillants 1
Bois spéciaux brillants 2
Bois spéciaux opaques 3
Or/argent feuille opaque
Or/argent feuille brillant
Bois spéciaux brillants 3
Chataignier Massif

	altezza height hauteur	A	B	C	D	E	F	G	H	I	L	M	N	O	P	Q	R	Z
BASI PROF. 61,2 base unit depth 61,2 bases prof. 61,2	54			97		58	54	97	138	134	155	170	184	294	124	137	327	219
	60	50	50	104	97	64	62	107	153	149	174	190	204	328	139	152	363	243
	72	57	59	110	115	67	64	127	172	179	192	205	222	359	165	183	392	290
	84			110		70	69	143	194	195	232	234	252					339
	87*	64	69	117	134	79	75	148	204	205	237	247	265	369	200	220	409	352
	92*			123		88	82	162	224	225	257	270	290					
COLONNE PROF. 61,2 columns depth 61,2 colonnes prof. 61,2	96	70	74	132	150	89	80	167	219	238	253	264	283	480	234	247	509	387
	132	95	104	188	199	120	115	222	307	325	299	379	408	629	260	329	690	533
	144			205		137	129	248	345	365	337	427	459					580
	186			273		170	153	323	407	453	405	492	529	825	342	423	913	749
	192	132	138	272	290	177	155	333	413	463	418	500	538	852	353	438	940	773
	204	145	145	282	308	179	159	340	418	470	437	509	548	943	464	505	1.019	823
	216			299		195	175	373	457	514	475	555	597					870
	228	163	170	317	342	208	189	379	464	528	555	572	614	1.064	479	573	1.153	919
SOPRALZO PROF. 61,2 top column depth 61,2 surélévation prof. 61,2	24	28	22	43	47	29	23	52	78	73	100	94	100	167	58	70	182	122
	36	35	27	60	62	34	29	67	112	92	137	134	144	203	75	90	242	159
	54			99		58	54	97	138	134	155	170	184	294	124	137	327	219
	60	54	50	108		64	62	107	153	149	174	190	204	328	139	152	363	243

* per fianco finale laterale vedi pag. 84, pag. 96

pour coté final lateral voir pag.84, pag. 96

for additional side panel see pag.84, pag. 96

Coprifianchi in metallo sp. 1 mm

Additional metal overs for visible side panels, 1 mm thick
Cotés à couvrir en métal ép. 1 mm

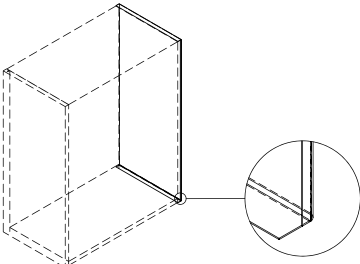
	ALTEZZA HEIGHT HAUTEUR	ACCIAIO SATINATO		ACCIAIO LUCIDO		GUN METAL		CORTEN		FINITURE (**)		RAME/OTTONE LUCIDO		
		cm	CODICE	PREZZO	CODICE	PREZZO	CODICE	PREZZO	CODICE	PREZZO	CODICE	PREZZO	CODICE	PREZZO
 <p>basi prof. 56,2 base units depth 56,2 bases prof. 56,2</p>	*32,5	0078219	64	0079219	82	-	-	-	-	-	-	-	-	
	54	0078220	124	0079220	160	0080001	182	0080031	200	0080061	282	0080091	300	
	72	0078221	139	0079221	172	0080002	207	0080032	225	0080062	338	0080092	357	
	84	0078224	150	0079224	195	0080003	225	0080033	250	0080063	382	0080093	400	
	<p>basi prof. 61,2 base units depth 61,2 bases prof. 61,2</p>	54	0078222	133	0079222	172	0080004	194	0080034	207	0080064	300	0080094	313
		72	0078223	148	0079223	198	0080005	213	0080035	238	0080065	363	0080095	382
		84	0078225	174	0079225	227	0080006	238	0080036	257	0080066	400	0080096	425
		<p>pensili wall cabinet hauts</p> <p>* per base zoccolo h. 33 (fianco 33) 1 cestello for plinth base unit h. 33 (side panel 33), 1 basket pour base socle h. 33 (côté 33) 1 panier</p> <p>(**) LS3 RAME ANTICATO LS4 OTTONE BRUNITO LA4 SATINATO GOLD LA5 BROWN BRONZE LA6 OTTONE SPAZZOLATO LA7 RAME SPAZZOLATO</p>	36	0078230	94	0079230	123	0080007	144	0080037	150	0080067	182	0080097
	54		0078231	104	0079231	134	0080008	157	0080038	169	0080068	219	0080098	232
	60		0078226	104	0079226	134	0080009	163	0080039	169	0080069	232	0080099	244
	72		0078232	113	0079232	145	0080010	169	0080040	182	0080070	257	0080100	269
	96		0078234	128	0079234	165	0080011	194	0080041	207	0080071	300	0080101	319
132	0078227		158	0079227	204	0080012	225	0080042	244	0080072	375	0080102	400	
<p>colonne prof. 56,2 columns depth 56,2 colonne prof. 56,2</p>	132		0078239	212	0079239	275	0080013	288	0080043	325	0080073	532	0080103	569
	144		0078228	220	0079228	287	0080014	300	0080044	344	0080074	569	0080104	607
	186	0078241	258	0079241	334	-	-	-	-	-	-	-	-	
	204	0078245	280	0079245	364	0080015	382	0080045	438	0080075	757	0080105	813	
	216	0078229	290	0079229	377	0080016	400	0080046	457	0080076	794	0080106	857	
	228	0078246	300	0079246	389	0080017	413	0080047	475	0080077	838	0080107	900	
	248	0078237	397	0079237	514	0080018	438	0080048	507	0080078	900	0080108	969	
	<p>colonne prof. 61,2 columns depth 61,2 colonne prof. 61,2</p>	132	0078253	225	0079253	293	0080019	300	0080049	338	0080079	569	0080109	607
144		0078238	234	0079238	304	0080020	319	0080050	363	0080080	613	0080110	650	
186		0078251	272	0079251	353	-	-	-	-	-	-	-	-	
204		0078254	294	0079254	383	0080021	407	0080051	469	0080081	813	0080111	882	
216		0078247	307	0079247	398	0080022	425	0080052	488	0080082	857	0080112	925	
228		0078248	317	0079248	412	0080023	438	0080053	507	0080083	900	0080113	969	
248		0078249	417	0079249	542	0080024	469	0080054	544	0080084	969	0080114	1.044	

Coprifondo in acciaio satinato sp. 1 mm per pensili

Satin steel cover for wall cabinet bottoms 1 mm thick
Fond à couvrir en acier satiné ép. 1 mm pour hauts

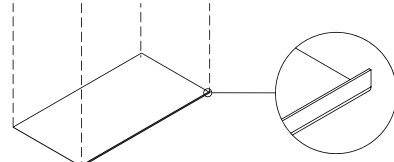
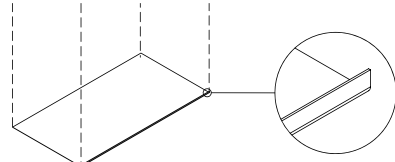
	LARGHEZZA WIDTH LARGEUR	CODICE CODE CODE	PREZZO PRICE PRIX	Coprifondo in acciaio lucido sp. 1 mm per pensili					
				LARGHEZZA WIDTH LARGEUR	CODICE CODE CODE	PREZZO PRICE PRIX			
 <p>N.B.: quando il coprifondo è abbinato al coprifianco acciaio, togliere 18 mm di larghezza alla misura del fondo (per ogni coprifianco)</p> <p>When the bottom and sides coverings are matched together cut 18 mm of the bottom covering (for each side covering)</p> <p>Quand le couvre fond et combiné avec un couvre côté acier, enlever 18 mm. À la largeur du couvre fond</p>	prof. 35,2	30	0078260	20	 <p>N.B.: quando il coprifondo è abbinato al coprifianco acciaio, togliere 18 mm di larghezza alla misura del fondo (per ogni coprifianco)</p> <p>When the bottom and sides coverings are matched together cut 18 mm of the bottom covering (for each side covering)</p> <p>Quand le couvre fond et combiné avec un couvre côté acier, enlever 18 mm. À la largeur du couvre fond</p>	prof. 35,2	30	0078260	20
	40	0078261	23	40		0078261	23		
	45	0078262	24	45		0078262	24		
	60	0078263	30	60		0078263	30		
	80	0078264	38	80		0078264	38		
	90	0078265	43	90		0078265	43		
	120	0078266	57	120		0078266	57		
	m.l.	0078267	64	m.l.		0078267	64		
	<p>prof. 56,2</p>	30	0078270	39		prof. 56,2	30	0078270	39
		40	0078271	45		40	0078271	45	
45		0078272	53	45	0078272	53			
60		0078273	65	60	0078273	65			
80		0078274	82	80	0078274	82			
90		0078275	94	90	0078275	94			
120		0078276	124	120	0078276	124			
m.l.		0078277	110	m.l.	0078277	110			



Pannelli vari (prezzi al mq)

Additional panels (price per sq.m.)
Panneaux additionals (prix au m.c.)

Legenda finiture pannelli

Legend to the chart of additional panels
Indications pour finissage panneaux additionals

A_ Materiale struttura + Corex
B_ Atelier Laccato Opaco
C_ Laminato
D_ Atelier Laccato Lucido
E_ Rovere
F_ Laccato Opaco
G_ Laccato Lucido
H_ Legni Speciali Opachi
I_ Laccato Metallizzato / Cemento
L_ Legni Speciali Opachi 2
M_ Legni Speciali Lucidi 1
N_ Legni Speciali Lucidi 2
O_ Legni Speciali Opachi 3
P_ Foglia Oro/Arg Opaco
Q_ Foglia Oro/Arg Lucido
R_ Legni Speciali Lucidi 3
S_
T_ Acciaio satinato
U_ Acciaio lucido
Z_ Massello castagno

Structure finish + Corex
Atelier matt lacquered
Laminate
Atelier glossy lacquered
Oak
Matt lacquered
Glossy lacquered
Matt special woods 1
Metallic glossy lacquered/Cement
Matt special woods 2
Glossy special woods 1
Glossy special woods 2
Matt special woods 3
Gold /Silver leaf matt
Gold /Silver leaf glossy
Glossy special woods 3

Satin stainless steel
Glossy stainless steel
Solid Chestnut

Structure décor + Corex
Atelier laqué opaque
Laminé
Atelier laqué brillant
Chêne
Laqué opaque
Laqué brillant
Bois spéciaux opaques 1
Laqué métallisé/Ciment
Bois spéciaux opaques 2
Bois spéciaux brillants 1
Bois spéciaux brillants 2
Bois spéciaux opaques 3
Or/argent feuille opaque
Or/argent feuille brillant
Bois spéciaux brillants 3

Acier Satiné
Acier Brillant
Chataignier Massif

	codice code code	A	B	C	D	E	F	G	H	I	L	M	N	O	P	Q	R	S	T	U	Z
Pannelli materiale struttura Panels same as structure Panneaux memes que la structure	sp. 18 mm th.18 mm ép.18 mm 0079000	137																			
Pannelli finitura texture decors 2 lati Panels same finishing as door Texture Decors Panneaux meme fin. De la porte Texture Decors	sp. 18 mm th.18 mm ép.18 mm 0079050	137																			
Pannelli finitura anta 1 lato Panels 1 side same finishing as door th. Panneaux 1 coté meme finition de la porte	sp. 18 mm th.18 mm ép.18 mm 0079100		194	335	345	305	214	383	460	538	515	568	610	729	464	485	939				
Pannelli finitura anta 2 lati Panels 2 sides same finishing as door th. Panneaux 2 coté meme finition de la porte	sp. 18 mm th.18 mm ép.18 mm 0079110 sp. 12 mm th.12 mm ép.12 mm 0075896		244	460	447	439	270	495	627	634	802	722	777	1.149	1.089	1.157	1.335				825
			244	460	447	439	270	495	627	634	802	722	777	1.149	1.089	1.157	1.335		475	597	

Dimensioni massime h. 250x90 cm

Maximum dimension h. cm 250x90
Dimension maxime h. cm 250x90

Minimo fatturabile 0,3 mq

Minimum billable 0,3 s.q.
Minimum facturabile 0,3 mètre carré

Pannelli in multistrato (prezzo da sommare al mq) Plywood panels (price to add per sq.meter) Panneaux en multipli (prix ajouter au mètre carré)	-	59	59	59	59	59	59	59	59	59	59	59	59	59	59	59					
Lavorazione per predisposizione retro base Fixed add. charge for processing back panelling base units Prix fixe pour travail arrière-base	9704022	112	112	112	112	112	112	112	112	112	112	112	112	112	112	112					
Maggiorazione per luce led sotto il pannello (*) Supplement for led light under panel (*) Majoration pour lumineux led sous le panneau (*)	9704348	155	155	155	155	155	155	155	155	155	155	155	155	155	155	155					

(*) Luce LED vedi pag. 371 Elementi Lineari - cod. 0075514 / 0075475 (USA)

(*) LED light see page 371 elementi lineari price list code 0075514 / 0075475 (USA)

(*) Light LED voir page 371 list elementi lineari code 0075514 / 0075475 (USA)