

Bar counter

Box neutri <i>Box neutri</i>	7
Celle refrigerate <i>Chilled cells</i>	9
Angoli interni <i>Internal corners</i>	11
Angoli esterni <i>External corners</i>	12
Modulo granite <i>Granite module</i>	13
Top <i>Top</i>	14
Banchi WSC cocktail + Topping <i>Counter WSC cocktail + topping</i>	15
Top per WSC + Topping <i>Top for WSC + Topping</i>	16
Moduli pozzetti gelato statici a glicole <i>Static glycol ice cream carapine</i>	17
Top per moduli pozzetti gelato statici a glicole <i>Top for glycol static ice cream modules</i>	19
Moduli pozzetti gelato ventilati <i>Ventilated ice cream modules</i>	20
Top per moduli pozzetti gelato ventilati <i>Top for ventilated ice cream modules</i>	21
Difesa in vetro con colonnine <i>Glass defense with columns</i>	22
Modulo Cassa + MC <i>Cash box + MC</i>	23
Modulo drop in <i>Drop in module</i>	24
Top + Teca per drop in <i>Top + Teca for drop in</i>	30
Teche in vetro <i>Glass cases</i>	32
Vetrine snack VDB <i>VDB snack cabinets</i>	33
Vetrine snack VDA <i>VDA snack cabinets</i>	37

Retrobanchi *back counters*

Retrobanchi neutri <i>Neutral backdrops</i>	49
Celle refrigerate <i>Chilled cells</i>	54
Modulo granite <i>Granite module</i>	61
Top Retrobanchi <i>Retro Backs</i>	62
Moduli pozzetti gelato ventilati <i>Ventilated ice cream modules</i>	65
Top per moduli pozzetti retrobanchi <i>Top for back counter manhole modules</i>	66
Moduli pozzetti gelato statici a glicole <i>Static glycol ice cream carapine</i>	67
Top per moduli pozzetti gelato statici a glicole <i>Top for glycol static ice cream modules</i>	69
Alzate retrobanco <i>Back counter-counter</i>	70
Accessori alzate <i>Raised accessories</i>	72
Cesti pane asola <i>Baskets bread asola</i>	74
Cesti pane spiga <i>Spiga bread baskets</i>	75
Fianchi terminali <i>Terminal flanks</i>	76

Optional *Optional*

Ante per retrobanchi neutri <i>Doors for neutral back counters</i>	80
Attrezzaggi per box L.37,5 <i>Tooling for boxes L.37,5</i>	82
Attrezzaggi per box L.50 <i>Tooling for box L.50</i>	84
Attrezzaggi per box L.62,5 <i>Tooling for boxes L.62.5</i>	87
Attrezzaggi per box L.75 <i>Tooling for box L.75</i>	89
Attrezzaggi per box L.100 <i>Tooling for box L.100</i>	90
Attrezzaggi per box L.125 <i>Tooling for box L.125</i>	91
Optional <i>Optional</i>	92
Lavelli a saldare <i>Sinks soldered</i>	93
Lavelli ad incasso <i>Built-in sinks</i>	94
Optional <i>Optional</i>	95
Optional cella <i>Optional cell</i>	99
Parti di ricambio per box <i>Spare parts for boxes</i>	101
Parti di ricambio per celle <i>Spare parts for cells</i>	102
Accessori per vetrine snack <i>Accessories for snack counter</i>	103
Optional <i>Optional</i>	105
Zoccoli banco bar <i>Bench bar clogs</i>	107
Zoccoli RTB <i>RTB sockets</i>	108
Detrazione unità refrigerante non fornita <i>Refrigeration unit deduction not supplied</i>	109
Supplemento unità refrigerante entro 10 mt equivalenti <i>Cooling unit surcharge within 10 meters equivalent</i>	110
Supplemento unità refrigerante entro 20 mt equivalenti <i>Cooling unit surcharge within 20 meters equivalent</i>	111

Componenti *Components*

Celle refrigerate incasso <i>Recessed refrigerated cells</i>	114
Vasche drop in <i>Tubs drop in</i>	118

Complementi vintage *Vintage accessories*

Struttura in tubo vintage <i>Structure in vintage tube</i>	124
Espositori a parete <i>Wall exhibitors</i>	126

Difesa in vetro con colonnine

Glass defense with columns

Bar

Difesa in vetro senza mensole

Glass defense without shelves

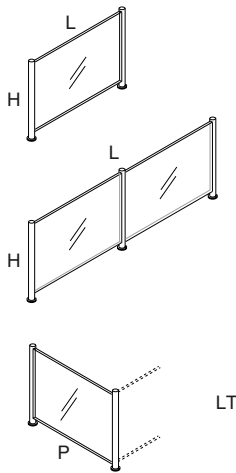

	P	H	L	Kg	Codice / Code	€
		60	100		4708404/1	€ 692,00
		60	125		4708406/1	€ 707,00
		60	150		4708408/1	€ 1.005,00
		60	175		4708410/1	€ 1.019,00
		60	200		4708412/1	€ 1.049,00
		60	225		4708414/1	€ 1.026,00
		60	250		4708416/1	€ 1.078,00
		60	AEp 90°		4708429/1	€ 990,00
LT	70	60			4708490/1	€ 438,00

Difesa in vetro con 1 mensola

Glass defense with 1 shelf

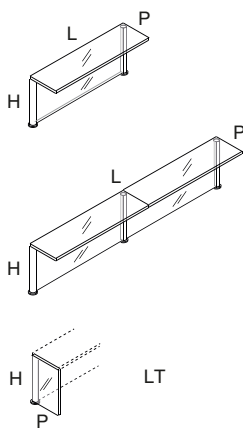

	P	H	L	Kg	Codice / Code	€
	20	40	100		4708504/1	€ 927,00
	20	40	125		4708506/1	€ 942,00
	20	40	150		4708508/1	€ 1.475,00
	20	40	175		4708510/1	€ 1.490,00
	20	40	200		4708512/1	€ 1.520,00
	20	40	225		4708514/1	€ 1.498,00
	20	40	250		4708516/1	€ 1.550,00
LT	20	40			4708590/1	€ 169,00

Difesa in vetro con 2 mensole

Defense in glass with 2 shelves

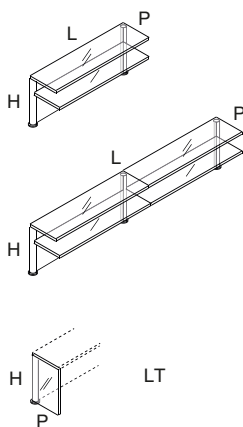

	P	H	L	Kg	Codice / Code	€
	20	40	100		4708604/1	€ 1.163,00
	20	40	125		4708606/1	€ 1.178,00
	20	40	150		4708608/1	€ 1.946,00
	20	40	175		4708610/1	€ 1.962,00
	20	40	200		4708612/1	€ 1.990,00
	20	40	225		4708614/1	€ 1.969,00
	20	40	250		4708616/1	€ 2.020,00
LT	80	40			4708690/1	€ 180,00

Modulo Cassa + MC

Cash box + MC

Bar

Bar
counter

Modulo cassa

Cash form

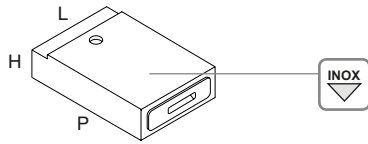

P	H	L	Kg	Codice / Code	€
64,5	18	50		4712500/1BW	€ 819,00

Piano inox per modulo cassa

Stainless steel top for cash desk module

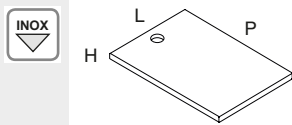

P	H	L	Kg	Codice / Code	€
51,2	3	50		4712510/1BW	€ 201,00

Modulo Macchina caffè

Coffee machine module

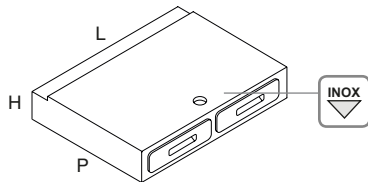

P	H	L	Kg	Codice / Code	€
64,5	18	93		4712520/1BW	€ 1.209,00

Nota: 1 cassetto con battifondi

1 cassetto cassa

Note: 1 Hopper hopper

1 Cash drawer

Piano inox per modulo macchina caffè

Stainless steel top for coffee machine module

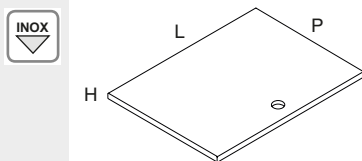

P	H	L	Kg	Codice / Code	€
51,2	3	100		4712530/1BW	€ 412,00
51,2	3	125		4712532/1BW	€ 639,00

Attrezzaggi per box L.37,5

Optional

Box a giorno per RMC L. 37,5

Open box for RMC L. 37,5

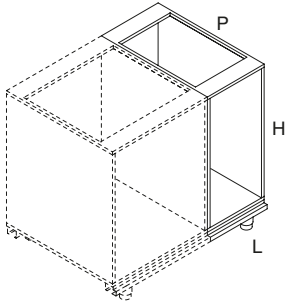

Nota: Da affiancare ad altro modulo per formare il RMC
Note: To be combined with another module to form RMC

	P	H	L	Kg	Codice / Code	€
SINOX	60	92	37,5		4700209/1BF	€ 346,00
	60	102	37,5		4700239/1BF	€ 375,00
	67	92	37,5		4700409/1BF	€ 375,00
	67	102	37,5		4700439/1BF	€ 405,00
	67	113	37,5		4700469/1BF	€ 441,00
INOX	60	92	37,5		4700209/1BW	€ 622,00
	60	102	37,5		4700239/1BW	€ 675,00
	67	92	37,5		4700409/1BW	€ 675,00
	67	102	37,5		4700439/1BW	€ 729,00
	67	113	37,5		4700469/1BW	€ 794,00

Cassetto cassa per box L. 37,5

Drawer box for box L. 37,5

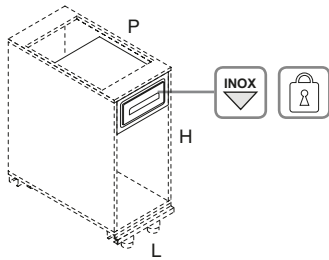

	P	H	L	Kg	Codice / Code	€
SINOX	44	21	37,5		4710309/1BF	€ 407,00
INOX	44	21	37,5		4710309/1BW	€ 428,00

Cassetto cassa ed anta per box L. 37,5

Drawer and door drawer for L. 37,5 box

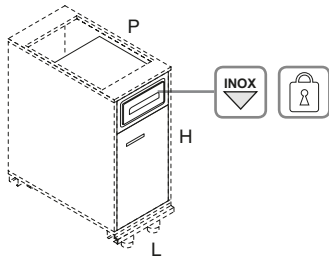

	P	H	L	Kg	Codice / Code	€
SINOX	44	92	37,5		4710409/1BF	€ 493,00
	44	102	37,5		4710419/1BF	€ 502,00
	44	113	37,5		4710429/1BF	€ 506,00
INOX	44	92	37,5		4710409/1BW	€ 574,00
	44	102	37,5		4710419/1BW	€ 590,00
	44	113	37,5		4710429/1BW	€ 596,00

Cassetto battifondi per box L. 37,5

Drawer drawer for box L. 37,5

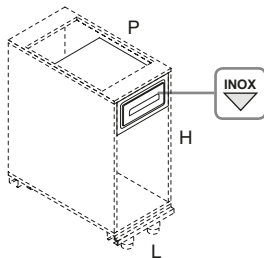

	P	H	L	Kg	Codice / Code	€
SINOX	44	21	37,5		4710359/1BF	€ 407,00
INOX	44	21	37,5		4710359/1BW	€ 428,00

Cassetto battifondi ed anta per box L. 37,5

Drawer drawer and door for box L. 37,5

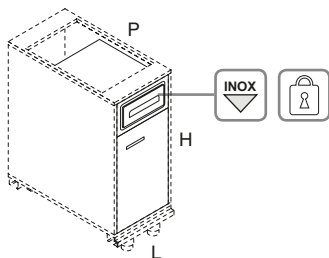

	P	H	L	Kg	Codice / Code	€
SINOX	44	92	37,5		4710439/1BF	€ 493,00
	44	102	37,5		4710449/1BF	€ 502,00
	44	113	37,5		4710459/1BF	€ 506,00
INOX	44	92	37,5		4710439/1BW	€ 574,00
	44	102	37,5		4710449/1BW	€ 590,00
	44	113	37,5		4710459/1BW	€ 596,00

Attrezzaggi per box L.37,5

Tooling for boxes L.37,5

Optional

Tramoggia battifondi per box L. 37,5

Hopper hopper for box L. 37,5

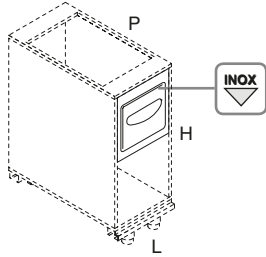

	P	H	L	Kg	Codice / Code	€
	24		37,5		4710769/1BF	€ 675,00
	24		37,5		4710769/1BW	€ 696,00

Tramoggia battifondi doppia per box L. 37,5

Double bed hopper for box L. 37,5

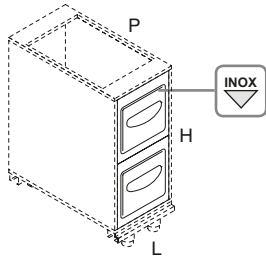

	P	H	L	Kg	Codice / Code	€
	38	92	37,5		4710709/1BF	€ 994,00
	38	102	37,5		4710719/1BF	€ 1.005,00
	38	113	37,5		4710729/1BF	€ 1.015,00
	38	92	37,5		4710709/1BW	€ 1.015,00
	38	102	37,5		4710719/1BW	€ 1.025,00
	38	113	37,5		4710729/1BW	€ 1.036,00

Tramoggia battifondi ed anta per box L. 37,5

Hopper and door hopper for box L. 37,5

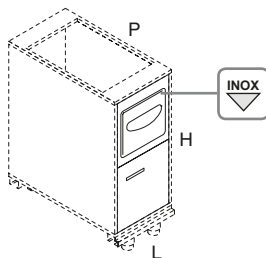

	P	H	L	Kg	Codice / Code	€
	24	92	37,5		4710739/1BF	€ 761,00
	24	102	37,5		4710749/1BF	€ 769,00
	24	113	37,5		4710759/1BF	€ 773,00
	24	92	37,5		4710739/1BW	€ 841,00
	24	102	37,5		4710749/1BW	€ 856,00
	24	113	37,5		4710759/1BW	€ 863,00

Optional
Optional

Celle refrigerate incasso

Recessed refrigerated cells

Componenti

Cella da incasso FULL statica

Static FULL built-in cell

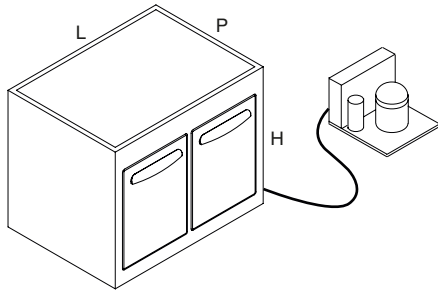

	P	H	L	Kg	Codice / Code	€
	55	80	54,5		4701120/1BW	€ 2.221,00
	55	80	100		4701122/1BW	€ 2.696,00
	55	80	150		4701124/1BW	€ 3.253,00
	55	80	200		4701126/1BW	€ 3.758,00
	55	80	250		4701128/1BW	€ 4.317,00
	55	80	300		4701130/1BW	€ 5.037,00
	67	80	54,5		4701160/1BW	€ 2.266,00
	67	80	100		4701162/1BW	€ 2.751,00
	67	80	150		4701164/1BW	€ 3.319,00
	67	80	200		4701166/1BW	€ 3.834,00
	67	80	250		4701168/1BW	€ 4.406,00
	67	80	300		4701170/1BW	€ 5.140,00

Nota: Vano motore a sx su richiesta
Note: Engine compartment on the left on request

Cella da incasso FULL statica con vano motore

Static FULL built-in cell with engine compartment

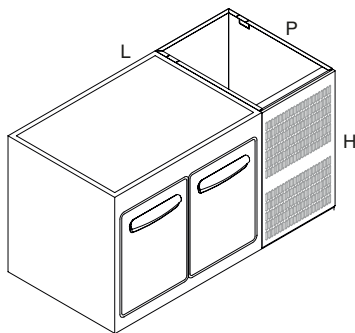

	P	H	L	Kg	Codice / Code	€
	55	80	100		4701102/1BW	€ 2.551,00
	55	80	150		4701104/1BW	€ 3.026,00
	55	80	200		4701106/1BW	€ 3.583,00
	55	80	250		4701108/1BW	€ 4.088,00
	55	80	300		4701110/1BW	€ 4.647,00
	55	80	350		4701112/1BW	€ 5.367,00
	67	80	100		4701142/1BW	€ 2.596,00
	67	80	150		4701144/1BW	€ 3.080,00
	67	80	200		4701146/1BW	€ 3.649,00
	67	80	250		4701148/1BW	€ 4.164,00
	67	80	300		4701150/1BW	€ 4.735,00
	67	80	350		4701152/1BW	€ 5.470,00

Nota: Vano motore a sx su richiesta
Note: Engine compartment on the left on request

Celle refrigerate incasso

Recessed refrigerated cells

Componenti

Cella da incasso FULL ventilata

FULL ventilated recessed cell

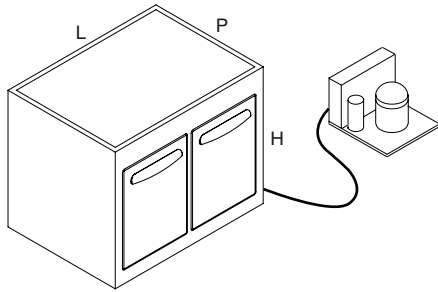

	P	H	L	Kg	Codice / Code	€
	55	80	100		4701422/1BW	€ 2.900,00
	55	80	150		4701424/1BW	€ 4.151,00
	55	80	200		4701426/1BW	€ 4.958,00
	55	80	250		4701428/1BW	€ 5.754,00
	55	80	300		4701430/1BW	€ 6.447,00
	67	80	100		4701462/1BW	€ 2.960,00
	67	80	150		4701464/1BW	€ 4.236,00
	67	80	200		4701466/1BW	€ 5.059,00
	67	80	250		4701468/1BW	€ 5.871,00
	67	80	300		4701470/1BW	€ 6.579,00

Cella da incasso FULL ventilata con vano motore

FULL ventilated recessed cell with engine compartment

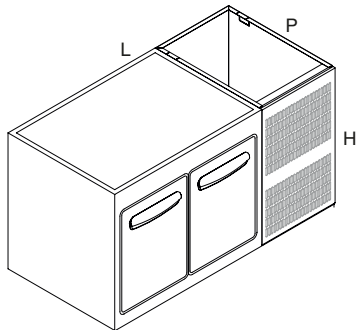

	P	H	L	Kg	Codice / Code	€
	55	80	150		4701404/1BW	€ 3.230,00
	55	80	200		4701406/1BW	€ 4.481,00
	55	80	250		4701408/1BW	€ 5.287,00
	55	80	300		4701410/1BW	€ 6.084,00
	55	80	350		4701412/1BW	€ 6.777,00
	67	80	150		4701444/1BW	€ 3.289,00
	67	80	200		4701446/1BW	€ 4.565,00
	67	80	250		4701448/1BW	€ 5.388,00
	67	80	300		4701450/1BW	€ 6.201,00
	67	80	350		4701452/1BW	€ 6.909,00

Nota: Vano motore a sx su richiesta
Note: Engine compartment on the left on request

Celle refrigerate incasso

Recessed refrigerated cells

Componenti

Cella da incasso FULL statica con evaporatore a scomparsa

Static FULL built-in cell with concealed evaporator

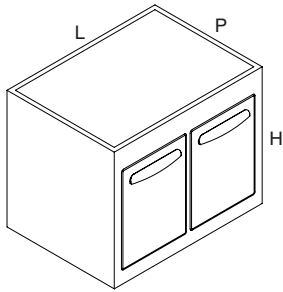

	P	H	L	Kg	Codice / Code	€
	55	80	54,5		4701720/1BW	€ 2.726,00
	55	80	100		4701722/1BW	€ 3.201,00
	55	80	150		4701724/1BW	€ 3.758,00
	55	80	200		4701726/1BW	€ 4.263,00
	55	80	250		4701728/1BW	€ 4.822,00
	55	80	300		4701730/1BW	€ 5.542,00
	67	80	54,5		4701760/1BW	€ 2.771,00
	67	80	100		4701762/1BW	€ 3.255,00
	67	80	150		4701764/1BW	€ 3.824,00
	67	80	200		4701766/1BW	€ 4.339,00
	67	80	250		4701768/1BW	€ 4.911,00
	67	80	300		4701770/1BW	€ 5.645,00

Cella da incasso FULL statica con evaporatore a scomparsa con vano motore

Static FULL built-in cell with hidden evaporator with engine compartment

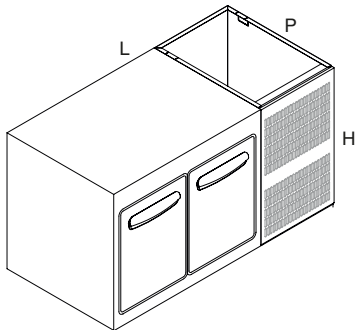

	P	H	L	Kg	Codice / Code	€
	55	80	100		4701702/1BW	€ 3.055,00
	55	80	150		4701704/1BW	€ 3.530,00
	55	80	200		4701706/1BW	€ 4.088,00
	55	80	250		4701708/1BW	€ 4.592,00
	55	80	300		4701710/1BW	€ 5.152,00
	55	80	350		4701712/1BW	€ 5.871,00
	67	80	100		4701742/1BW	€ 3.101,00
	67	80	150		4701744/1BW	€ 3.585,00
	67	80	200		4701746/1BW	€ 4.153,00
	67	80	250		4701748/1BW	€ 4.668,00
	67	80	300		4701750/1BW	€ 5.240,00
	67	80	350		4701752/1BW	€ 5.974,00

Nota: Vano motore a sx su richiesta
Note: Engine compartment on the left on request

Vasche drop in

Tubs drop in

Componenti

Vasca drop in refrigerato

Tub drop in refrigerated

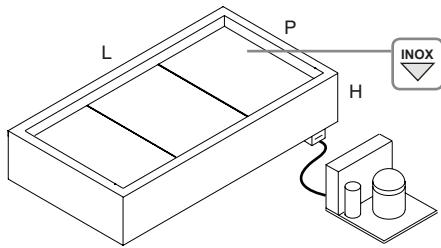

P	H	L	Kg	Codice / Code	€
67	27	100		4702404/1	€ 2.905,00
67	27	125		4702406/1	€ 3.148,00
67	27	150		4702408/1	€ 3.377,00
67	27	175		4702410/1	€ 3.633,00
67	27	200		4702412/1	€ 3.982,00
67	27	100		4702424/1	€ 2.765,00
67	27	125		4702426/1	€ 2.995,00
67	27	150		4702428/1	€ 3.206,00
67	27	175		4702430/1	€ 3.447,00
67	27	200		4702432/1	€ 3.779,00

Vasca drop in combinato

Tub drop in combination

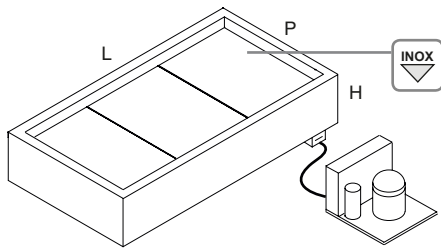

P	H	L	Kg	Codice / Code	€
67	27	100		4702604/1	€ 3.612,00
67	27	125		4702606/1	€ 3.855,00
67	27	150		4702608/1	€ 4.083,00
67	27	175		4702610/1	€ 4.411,00
67	27	200		4702612/1	€ 4.760,00
67	27	100		4702624/1	€ 3.472,00
67	27	125		4702626/1	€ 3.701,00
67	27	150		4702628/1	€ 3.912,00
67	27	175		4702630/1	€ 4.223,00
67	27	200		4702632/1	€ 4.556,00

Vasca drop in praliniera

Tub drop in pralines

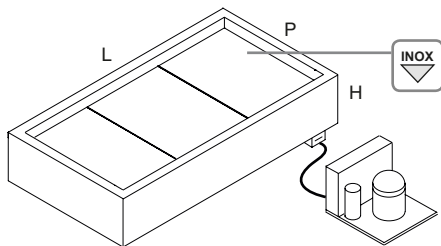

P	H	L	Kg	Codice / Code	€
67	27	100		4702504/1	€ 4.015,00
67	27	125		4702506/1	€ 4.259,00
67	27	150		4702508/1	€ 4.487,00
67	27	175		4702510/1	€ 4.744,00
67	27	200		4702512/1	€ 5.093,00
67	27	100		4702524/1	€ 3.875,00
67	27	125		4702526/1	€ 4.105,00
67	27	150		4702528/1	€ 4.316,00
67	27	175		4702530/1	€ 4.557,00
67	27	200		4702532/1	€ 4.889,00

Vasca drop in refrigerato statico

Tub drop in static refrigerated

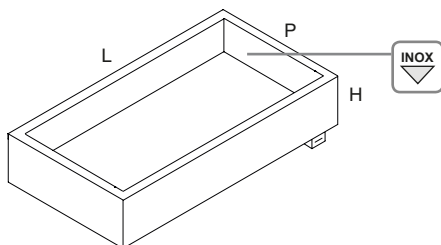

P	H	L	Kg	Codice / Code	€
67	27	100		4702304/1	€ 2.675,00
67	27	125		4702306/1	€ 2.909,00
67	27	150		4702308/1	€ 3.102,00
67	27	175		4702310/1	€ 3.327,00
67	27	200		4702312/1	€ 3.638,00
67	27	100		4702324/1	€ 2.535,00
67	27	125		4702326/1	€ 2.756,00
67	27	150		4702328/1	€ 2.930,00
67	27	175		4702330/1	€ 3.141,00
67	27	200		4702332/1	€ 3.435,00

Nota: Ordinare top specifico

Note: Order specific top